

L O F T™

# D3-Series Interactive Display User Manual



## Contents

Safety Warnings.....	3
FCC Statement.....	6
Control Panel .....	7
Remote Control.....	13
Connections and Settings.....	18
Troubleshooting.....	22

## Safety Warnings

Before operating, please read this manual thoroughly, and keep it for future reference. Image shown in this manual is indicative only. There may be differences between the pictures and the actual product.

### Placement

- Do not put heavy objects on top of the unit.
- Do not place the unit near appliances that generate magnetic fields.  
Do not expose the unit to direct sunlight and other sources of heat.
- Do not place the unit on an unstable cart, stand, tripod, bracket, table, or shelf.
- Do not put any liquid near or on the unit, make sure to not spill any liquid inside the unit.

### Power Supply

- Please keep power cable from physical or mechanical damage.
- Please check and ensure AC source is connected with the ground.
- This power cable comes with the device exclusively for this device only. Check that the unit's operating voltage is identical with your local power supply.
- Please unplug power supply during thunderstorms.
- Please use the original power cable from the accessory bag, don't modify or lengthen it.
- Please unplug power supply, when there is nobody home or the unit will be on standby for a long time.

## LED Screen

- Unplug the power cable before cleaning. Clean the screen with a soft, dustless and dry cloth.
- For deep cleaning, please contact an authorized service center.
- Never use water or the spray type detergent to clean the unit.
- Never use any other hard or sharp object to replace the touch pen.
- To preserve the panel, do not display static images on high brightness for extended periods of time.

## Temperature

- Normal operating temperature is 0~40 C.
- Do not place the unit near or over a radiator or a heater.
- If your unit is suddenly moved from a cold to a warm place, please unplug the power cable and do not turn it on at least 2 hours, making sure the moisture inside the unit is all evaporated.

## Humidity

- Do not expose the unit in rain, or place in high humidity area.
- Please make sure indoor environment is dry and cool. Normal operating humidity is 10%~ 90% RH.

## Ventilation

- Please put the unit in a well- ventilated place, so the heating can be released easily. Ensure that the unit has enough space for ventilation.
- Space requirement: left, right and back >10cm, top> 20cm.

## Earphones

- Before using earphone, please turn down the volume in advance. Listening at a high volume for long periods of time may affect hearing.

## Battery

- Please ensure the remote batteries are properly disposed of or recycled after using.
- Please keep the battery away from kids and don't throw the battery into fire.
- Caution risk of fire or explosion if the battery is replaced by an incorrect type.

## Notes for Cleaning

- There are vents on back cover, please do not use any liquid or spray directly during cleaning.

## Power Switch Status Signs

- “I” means power on, “O” means power off.

## Notes for Maintenance

- This machine can only be maintained by a certified engineer or technician.

## FCC Statement

This equipment has been tested and found to comply with the limits for a Class B digital device, pursuant to part 15 of the FCC Rules. These limits are designed to provide reasonable protection against harmful interference in a residential installation. This equipment generates, uses and can radiate radio frequency energy and, if not installed and used in accordance with the instructions, may cause harmful interference to radio communications. However, there is no guarantee that interference will not occur in a particular installation. If this equipment does cause harmful interference to radio or television reception, which can be determined by turning the equipment off and on, the user is encouraged to try to correct the interference by one or more of the following measures:

- Reorient or relocate the receiving antenna.
- Increase the separation between the equipment and receiver.
- Connect the equipment into an outlet on a circuit different from that to which the receiver is connected.
- Consult the dealer or an experienced radio/TV technician for help.

## FCC Warning

This device complies with Part 15 of the FCC Rules. Operation is subject to the following two conditions: (1) this device may not cause harmful interference, and (2) this device must accept any interference received, including interference that may cause undesired operation.

## Control Panel

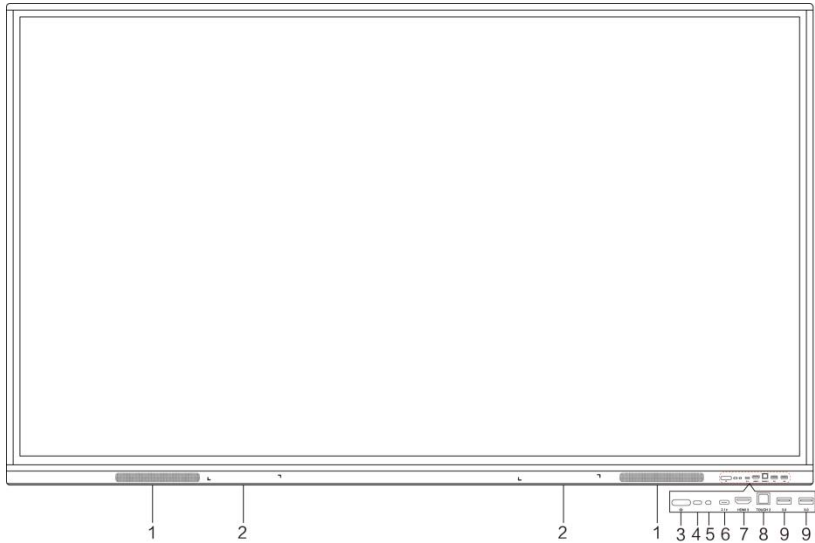

Number	Items	Function description
1	Loudspeaker	Amplify audio.
2	Magnetic zone	Area for placing the absorptive magnetic pen.

3		Tap to enter energy-saving, press for at least 2 seconds to enter standby mode.
4	Remote control signal receiver	Receive the remote signal.
5	Light Sensor	Identify the brightness of ambient light.
6	USB-C 3.1	Support charging, data transmission, extension for audio and video output interface, etc.  Note:The maximum rated power of the USB Type- C port of this product is 65W. When using this port to charge electronic devices, the charging power of the electronic device cannot exceed the rated power of this port. If the charging power of the electronic device exceeds the rated charging power of this port, please do not directly use this port for charging.



7	HDMI 3	High- definition multimedia interface signal input, connect to devices with HDMI output interface (personal computer with HDMI output, set- top box, or another video device).
8	TOUCH 2	Touch signal output to the external computer.
9	USB 3.0	Connect USB devices such as mobile hard disk, USB keyboard and mouse, USB drives, etc.

2: Terminal Interface

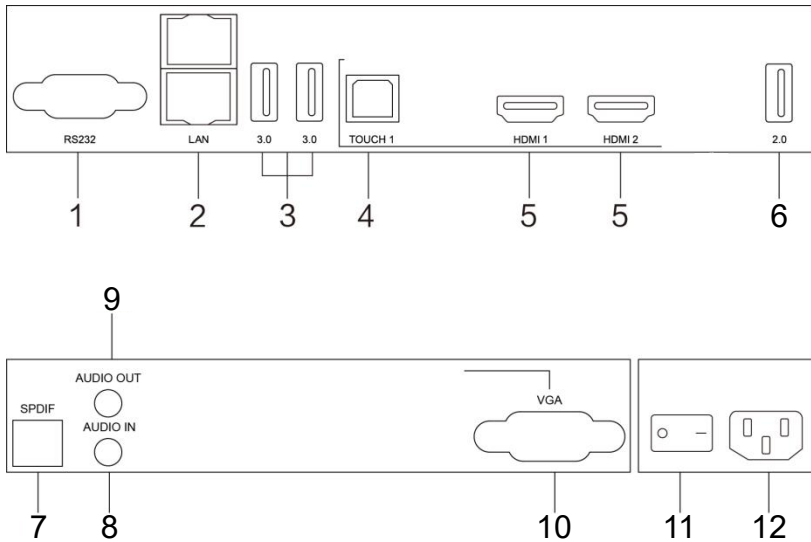





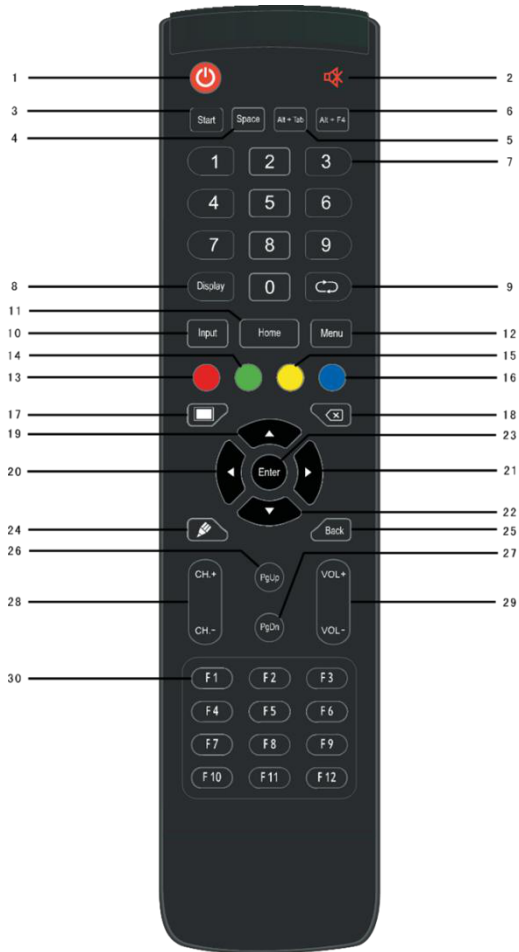

Number	Items	Function description
1	RS232	Serial interface, used for mutual transfer of data between devices.
2	LAN	Connect RJ45 terminals.
3	3.0	Connect USB devices such as mobile hard disk, U disk, USB keyboard and mouse, USB drives, etc.
4	TOUCH 1	Touch signal output to the external computer.
5	HDMI IN	High- definition multimedia interface signal input, connect to devices with HDMI output interface (personal computer with HDMI output, set- top box, or another video device).
6	USB 2.0	Connect USB devices such as mobile hard disk, USB keyboard and mouse, USB drives, etc.
7	SPDIF	Carry multichannel sound via optical signals.
8	AUDIO IN	External computer audio input.
9	AUDIO OUT	Audio output to the external speaker.
10	VGA	External computer image input.
11	AC SWITCH	To open or shut down AC power supply. "I" means power on, "O" means power off.
12	AC IN	AC power input, connect AC power supply.

## Remote Control

### Remote Control Button Instruction



		Function
1		Power on/off
2		Enter or exit mute mode
3	Start	PC's Windows key
4	Space	PC's Space key
5	Alt+Tab	PC's Alt+Tab key
6	Alt+F4	PC's Alt+F4 key
7	Numeric Keys	Numeric input keys
8	Display	Display channel information
9		/
10	Input	Pop up TouchMenu-General Setting
11	Home	Return to android system main screen key
12	Menu	Pop up TouchMenu-Audio
13	Red	Enable or disable Front keyboard and Touch
14	Green	Enable or disable Front keyboard
15	Yellow	Enable or disable Touch
16	Blue	Pop out or close the screen freezing tools
17		Turn off or turn on the screen backlight
18		PC's Backspace key
19	▲	Press to scroll up
20	◀	Press to scroll left
21	▶	Press to scroll right
22	▼	Press to scroll down
23	Enter	Confirmation key, press it to confirm selection state
24		Quickly start writing software
25	Back	Return to the last operating interface
26	PgUp	Page Up
27	PgDn	Page Down
28	CH.+ / CH.-	/
29	VOL+ / VOL-	Increase/reduce the volume
30	F1-F12	PC's F1 - F12 function keys

## Remote Control Instructions

### Install Batteries

1. Open back cover of battery component on the back of remote control.
2. Install AAA type battery according to the corresponding electrode, make sure battery positive and negative pole are correct ("+" to "+", "-" to "-"), please do not mix using old and new batteries.
3. After battery is installed, close the back cover of battery components, and make the following clip buckled to the bottom.

### Range of remote control

Remote control can work normally within the range of 8 meters distance, 30 degrees left and right from the remote control receiver. Please dispose of used batteries as directed by your local waste authority.



**If the battery is replaced by an incorrect type, it may lead to explosion.**

## Connections and Settings

For the safety of you and the machine, please do not connect any power plug before connection.

### 1. External Computer and Touch Connection

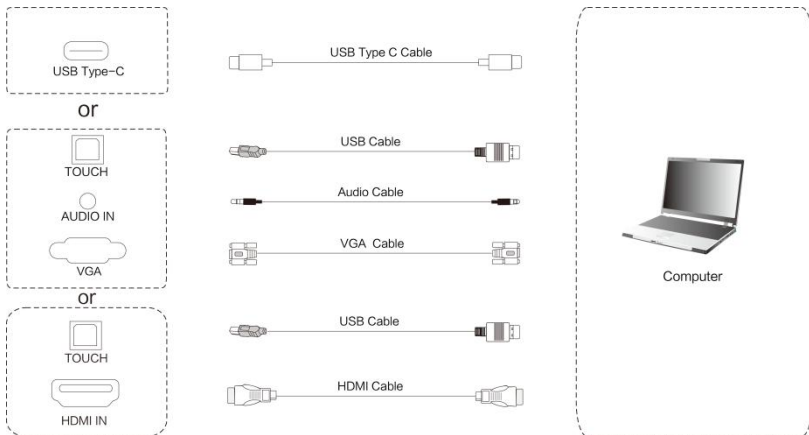

You can connect a PC to the display by:

- Using a USB Type C cable to connect the computer
- Using a VGA cable to connect to VGA output port of external computer, and a 3.5mm audio cable to connect to external computer audio output interface and a USB cable to connect to external computer.
- Using an HDMI cable to connect to HDMI output port of external computer and use USB cable to connect to external computer USB port).

After cable connection, plug in power cord, and switch power on.

Start external computer.

Press the  key, and the equipment will power on

Switch the input source to the USB Type C/V GA/HDMI channel in the main menu.

(Supports Resolutions: 800×600, 1024×768, 1920×1080, 3840×2160)

## NOTE:

With an external computer input, the equipment's maximum resolution is 3840x2160.

Minimum computer configuration:

1GB Available Hard Drive

2.0GHz Processor, 1 GB Memory

## 2. Audio and Video Equipment

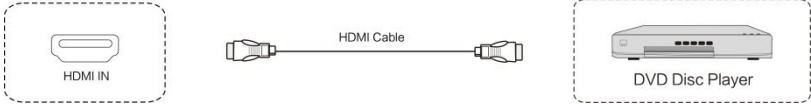

- Use HDMI cable to connect audio and video equipment with HDMI output.
- After cable connection, plug in power cord, and switch power on.
- Press **⏻** to turn equipment on.
- Switch the input source to the HDMI channel in the main menu.

## 3. Audio and Video Equipment

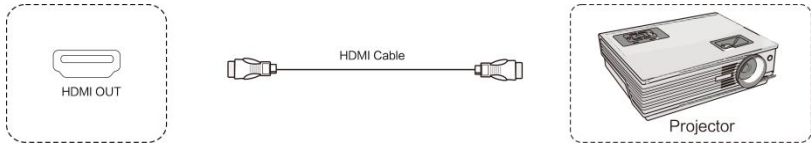

- Use HDMI cable to connect audio and video equipment with HDMI input.
- After cable connection, plug in power cord, and switch power on
- Press **⏻** to turn equipment on



## 4. RS232 Connection

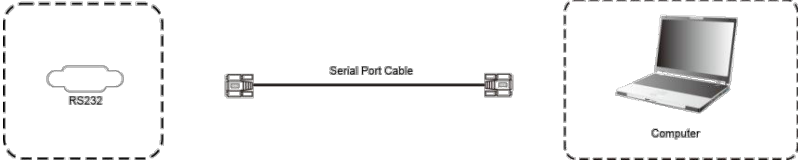

## 5. LAN Connection

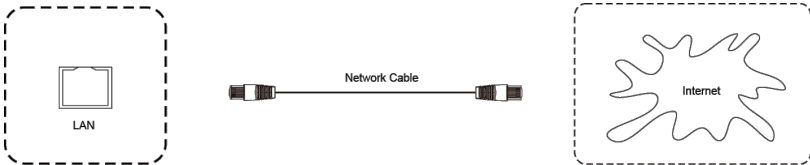

## 6. USB Connection

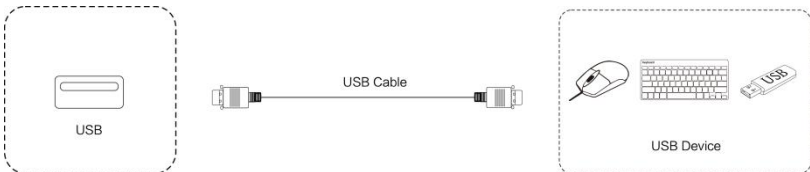

## 7. AUDIO OUT Connection

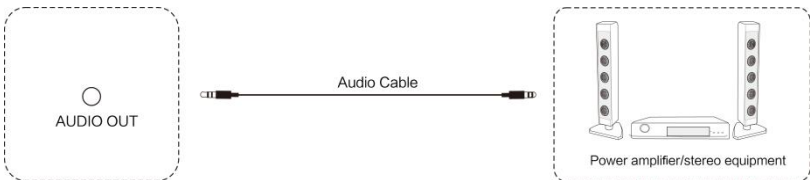

## Troubleshooting

### Machine Fails to Work Normally

Remote control failure	Check whether there are other objects between remote control and equipment control receiving window, thus leading to failure of remote control.
	Check whether the battery electrode in the remote control is correct.
	Check whether remote control needs new batteries.
Machine automatically shuts down	Check if the display is scheduled to go to sleep.
	Check if there is sudden power outage.
	The system will automatically shut down if the display is set to an external input and loses signal for 5 minutes. Please check the input and connection of the signal.

## PC Mode

Signal out of range	Check whether display is set correctly.
	Check whether resolution is the best resolution.
	Adjust line and field synchronization in menu.
Background has vertical lines or streaks	Select automatic correction in menu.
	Adjust clock and phase position in menu.
Image lack of color, color is incorrect	Check whether VGA is not well connected or has quality problem.
	Adjust chromatic and brightness or contrast in menu.
Display format that is not supported	Select automatic correction in menu.
	Adjust clock and phase position in menu.

## Touch Function

Touch function invalid	Check whether the size of article touched is comparable with finger.
Touch positioning not correct	Check whether touch pen is facing the screen.

## Video Function is Not Working Normally

No picture and no sound	Check whether the machine is started state.
	Check whether signal wire is properly connected, whether INPUT is corresponding to it.
	If the display is set to output the OPS-PC, check whether the OPS-PC is powered on.
With horizontal or vertical stripes or grainy images	Check whether signal wire is well connected.
	Check whether other electronic equipment or power tools are placed around the machine.
No color, color is weak, or image is weak	Adjust chromatic and brightness or contrast in menu.
	Check whether signal wire is properly connected.

## Audio Function Can't Work Normally

With image but without sound	Check whether mute button is pressed for mute.
	Press VOL + /- to adjust volume.
	Check whether audio line is connected correctly.
Only one speaker has sound	Adjust sound balance in menu.
	Check whether computer sound control panel only sets up one sound channel.
	Check whether audio line is connected correctly.
HDMI output without sound	Check if an external device is connected.

## **Maintenance**

Proper maintenance can avoid many early faults and regular careful cleaning can make machine brand new.

Please unplug power plug before cleaning and maintenance, to prevent electric shock.

## **Cleaning the Screen**

Please mix and stir even a little fabric softener or tableware detergent with alcohol.

Please use a soft cloth to be completely soaked in the mixture.

Please take out cloth and twist to half dry state to wipe machine screen.

Repeat for several times, pay attention not to squeeze water flow into machine when wiping machine.

## **Cleaning the Frame**

Please use a dry, soft, lint- free cloth to wipe front frame.

## **Long Periods Without Use**

If the display will be powered off for an extended period of time, please unplug the power cable to prevent any possible dangers caused by power surges.